

Ceramic Semi-Recessed Bathroom Sink

Specification & Installation Guide

FEATURES

- Design: Rectangular / Contemporary
- Material: Vitreous China
- Type: Semi-Recessed
- Overflow: Yes
- Size: 24-5/16"(618 mm)L x 18-5/16"(465 mm)W x 1-1/2"(37 mm)H
- Basin inside depth: 5" (127 mm)
- Drain ϕ : 1-3/4" (45 mm)
- Faucet hole ϕ : 1-3/8" (35mm) - Available in single-hole or 8" (203mm) centers
 - Single: CB-8124-110-WH
 - 8" center: CB-8124-130-WH
- Basin Clamp Assembly: Not applicable.
- Packaging Dimensions: 27"(686 mm) x 20"(508 mm) x 9" (229 mm)
- Weight: 36 lbs. / 16.36 kgs.

FINISHES

White

COMPLIANCE

CSA B45.5-11/IAPMO Z124-11

INSTALLATION

Follow the installation guide to install this product. Lavatory will comply with ADA when installed per section 606 Lavatories and Sinks of the 2012 ADA standards for Accessible Design. For the under-mount installation, countertop thickness cannot be over 1" (25 mm) for ADA compliance.

CB-8124-110-WH

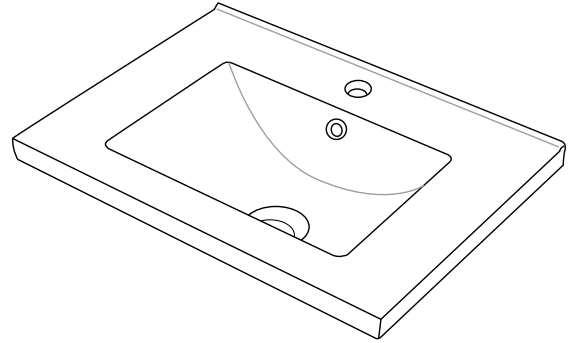

CB-8124-130-WH

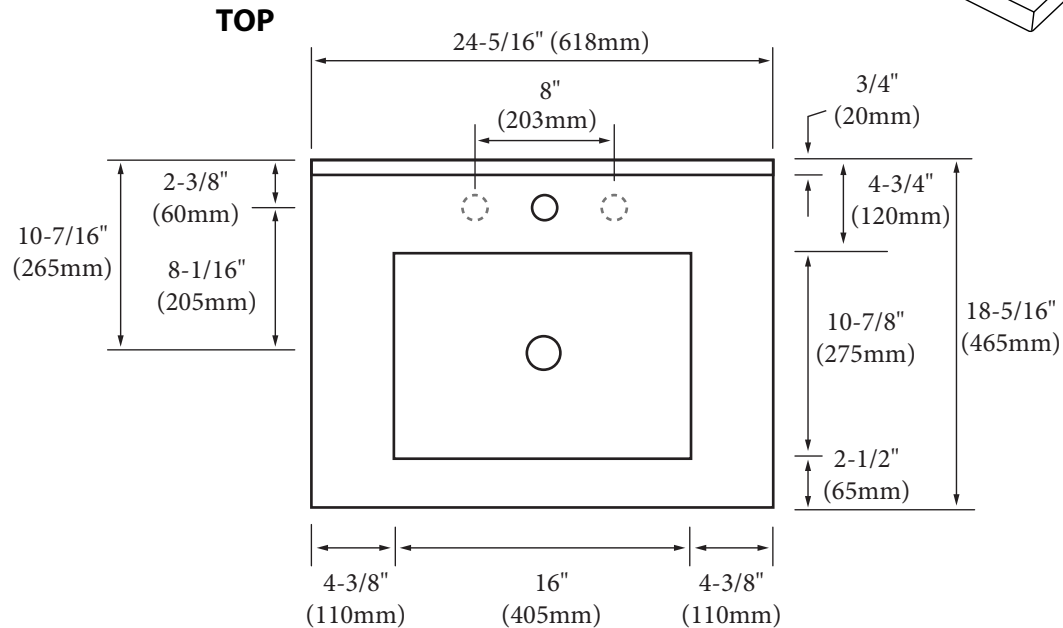
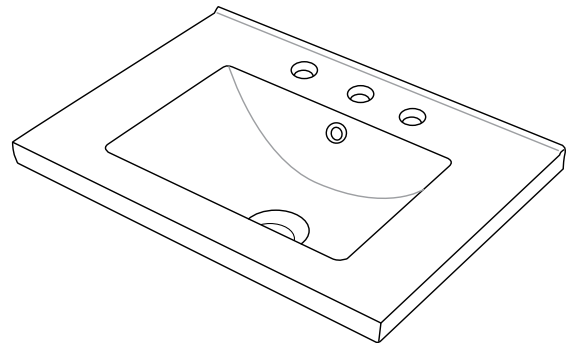

For clarification, please contact Madeli Customer Care at (800)-819-6988 or (305)-718-8817 Ext. 1

All dimensions are approximate and subject to standard tolerance. Specifications subject to change without prior notice.

Ceramic Semi-Recessed Bathroom Sink

Specification & Installation Guide

FRONT

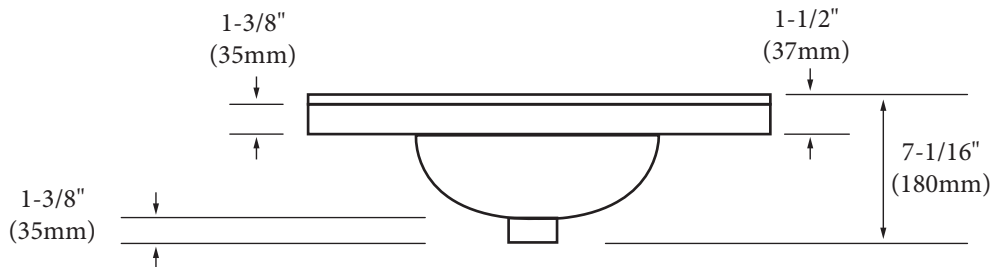

UNDERSIDE

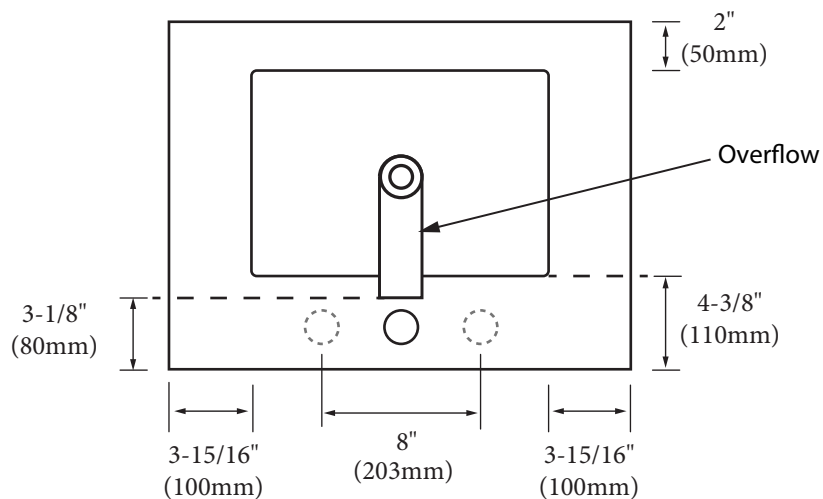

For clarification, please contact Madeli Customer Care at (800)-819-6988 or (305)-718-8817 Ext. 1

All dimensions are approximate and subject to standard tolerance. Specifications subject to change without prior notice.